

# MultisafeWay







Ø 23.0 mm

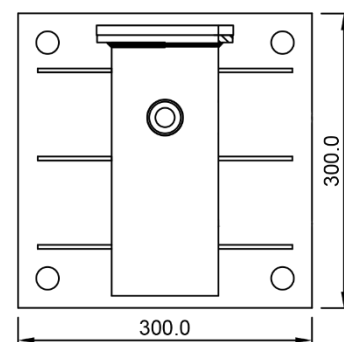
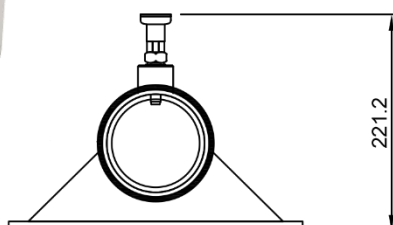

240.0 mm

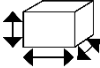

<b>HS CODE</b>
7610 90 10
<b>CARTON SIZE / PCS.</b>
34 X 34 X 34 cm / 1
<b>Certificate of test SPC0223656/1414 Issue 3 Extension 1</b>
<b>Satra Technology Centre, N° 0321</b> Wyndham Way, Telford Way, Kettering Northamptonshire, NN16 8SD, United Kingdom
<b>ACKNOWLEDGEMENT OF RECEIPT N°1120/1/2020</b>
<b>Technická Inšpekcia, a.s. N°1354</b> Trnavská cesta 56, 821 01 Bratislava, Slovenská Republika

REF.	FA 60 022 02
CE	EN 795:2012 Type A
	---
	---
MAT.	
	M16 (x4)
R (kN) / MBS (kN)	---
+	ATEX Directive, Machinery Directive 360° Rotation (8 positions)
	12.43 KG



**Nombre d'utilisateurs**  
Number of users  
**Cantidad de usuarios**  
Quantità di utilizzatori  
**Anzahl der Benutzer**



**Charge maxi admissible**  
Max. allowable load  
**Carga máxima admisible**  
Peso massimale  
**Zulässige Höchstlast**

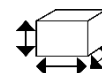

**Fixations à utiliser**  
Fasteners to use  
**Fijaciones que deben usarse**  
Elementi di fissaggio da utilizzare  
**Zu verwendende Befestigungen**